

## Main Specifications

Model	Standard Type							High-mast Type	
	8FBR10	8FBR13	8FBR15	8FBR18	8FBR20	8FBR25	8FBR30	8FBRS20	8FBRS25
Operation Position	Stand-up	Stand-up	Stand-up	Stand-up	Stand-up	Stand-up	Stand-up	Stand-up	Stand-up
Load Capacity	kg	1,000	1,250	1,500	1,800	2,000	2,500	3,000	2,000
Load Center	mm	500	500	500	500	500	500	500	500
Overall Width	A	mm	1,090	1,090	1,090	1,090	1,190	1,190	1,190
Turning Radius (Outside)	B	mm	1,340	1,490	1,580	1,730	1,750	1,950	2,000
Overhead Guard Height	C	mm	2,250	2,250	2,250	2,250	2,330	2,330	2,330
Length to Fork Face	D	mm	1,050	1,050	1,155	1,155	1,250	1,270	1,250

## Battery and Motor Specifications

Model	8FBR10	8FBR13	8FBR15	8FBR18	8FBR20	8FBR25	8FBR30	8FBRS20	8FBRS25
Voltage/Capacity (5-hour ratings)	Min	V/AH	48/201	48/201	48/280	48/280	48/320	48/320	48/390
	Max	V/AH	48/240	48/240	48/370	48/370	48/445	48/445	48/445
Electric Motors	Drive	kW	4.9	4.9	4.9	4.9	5.2	5.2	5.2
	Load Handling	kW	8	8	8	8	11	11	11
	Power Steering	kW	0.26	0.26	0.26	0.26	0.35	0.35	0.35

## Standard Type



8FBR15

8FBR30

No capacity reduction at lift height of 4m

## High-mast Type



8FBRS25

High-mast type is suitable for worksites need higher load stacking

Smaller capacity reduction at high lift height enables stable high-stacking operations, supporting effective use of space.

No capacity reduction at lift height of 5m

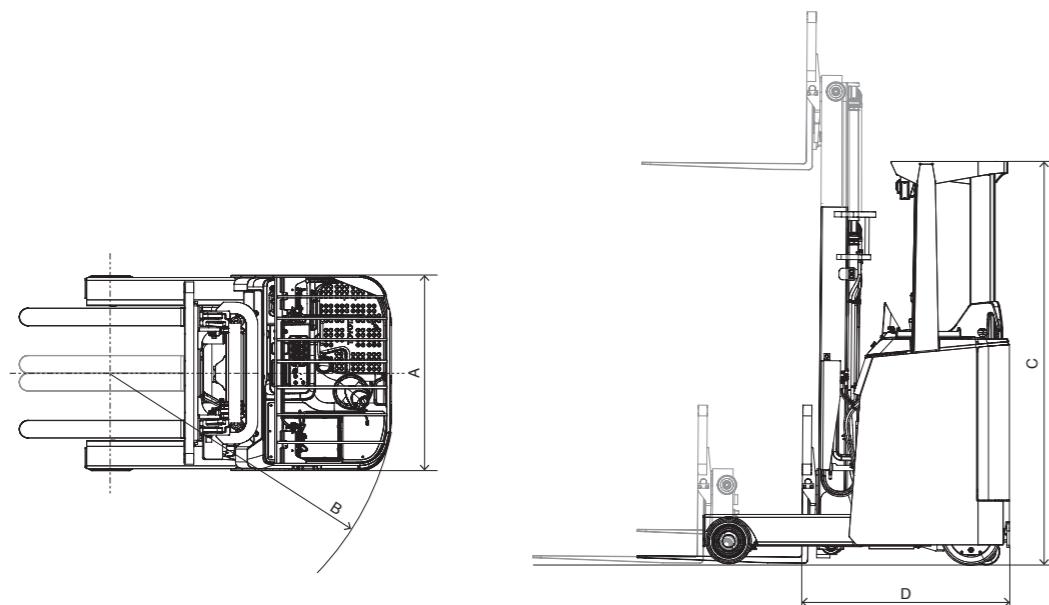

OPS does not operate the brakes. Always set the parking brake before leaving the forklift. Travel OPS is not available on manual transmission models. The data in this leaflet is determined based on our standard testing condition. The performance may vary depending on the actual specification and condition of the vehicle as well as the condition of the operating area. Availability and specifications depend on market and are subject to change without notice. Due to photography and printing, color of actual vehicle may vary from this leaflet. Some photos have been computer-enhanced. Please consult your Toyota representative for details.

All rights reserved by Toyota Industries Corporation.

# 8FBR

## SERIES





## High Performance and Big Productivity in a Compact Body.

How long reach truck can be used, how safe reach truck can be... Our challenge to create innovative truck delivers this model, 8FBR series.

Toyota's advanced technology providing long time, cost-effective and safe operation is mounted in new designed compact body.

# 8FBR SERIES

Toyota's Leading Technology is within Your Reach



# Long Operating Time and Long Battery Life for Your Long-lasting Business.



## Long Operating Time & Long Battery Life

### Long Operating Time

New highly efficient AC motors and motor drivers, regenerative braking that returns braking energy to the battery, and other design features achieve long operating time.

1.5t operating time	<b>9h 30min</b>	48V 280AH/5h
2.5t operating time	<b>7h 35min</b>	48V 320AH/5h
3.0t operating time	<b>11h 30min</b>	48V 445AH/5h

Notes: Operating time is based on Toyota operating cycle at S mode assumed that the forklift is actually operated in 55% of total working hours. Operating time may vary according to customer usage conditions.

Previous Model  
7FBR

8h40min

New Series  
8FBR

9h30min

Note: 1.5t(S mode).

Approx. **10% Longer Operating Time**

### Regenerative Systems

During switchback and braking by accelerator or foot pedal release, the energy is recovered in the battery for long operating time.

#### Switchback Regeneration

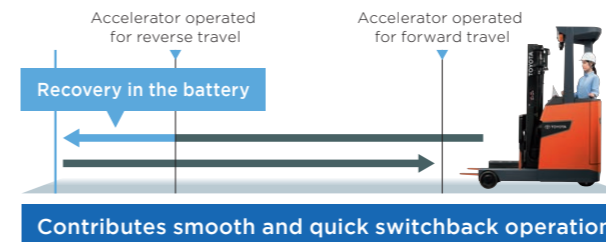

#### Accelerator-released Regeneration



### Smart Charging System

NEW Option

\*Only for on-truck charger

The motors and motor drivers are used to control the charging current according to the battery condition (voltage, fluid temperature, and deterioration state). This lessens battery damage and contributes less battery fluid reduction.



Charging current adjusted according to the state of the battery

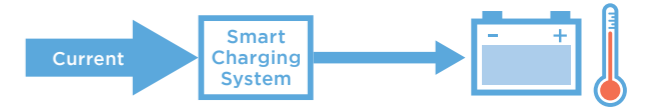

- Less battery damage
- Electricity costs reduced by up to 5%
- Battery-fluid refilling costs reduced by up to 50%

Note: May vary according to customer's usage conditions.

### Battery Protecting Function

Option

When the battery fluid level is low or the fluid temperature is high, this informs the operator by an indicator and audible warning, and also restricts travel performance. This helps prevent degradation of the battery and ensure a long life for the battery.

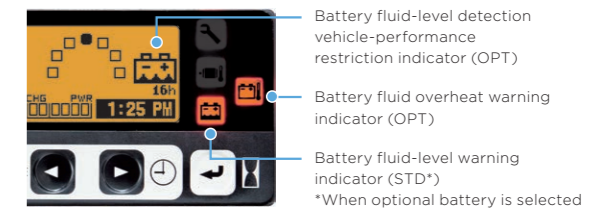

### Auto Power-off Function

The power is automatically switched off after the operator leaves the forklift for a specific period of time, supporting energy saving operation.

### Power-keep Function

The load-handling and travel performance are kept as the battery charge gets low, allowing continuing efficient operation.

### Power-select Function

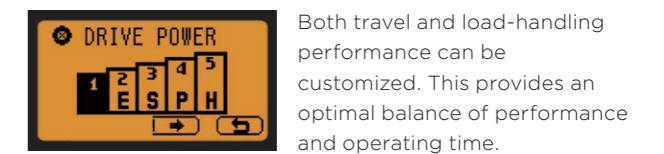

# Outstanding Stability during Turns and Load Handling Supports Efficient Work.



## Safety

### Rear-positioned Headguard Pillar

The headguard pillar located at the rear ensures outstanding forward visibility. This design also contributes to support and protect operator's back.



### Load Weight Indicator

When lifting operation is stopped, the load weight is shown on the display. This helps to prevent overload.



Note: This cannot be used for commercial transactions.

### Shockless Landing

\*Only for V, SV and FSV mast.

The speed of fork lowering automatically slows down just before contacting the ground, contributing to reduce the noise.

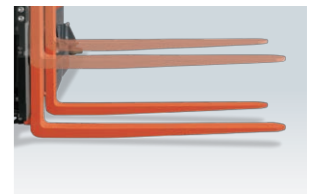

### Automatic Turn-speed Control

Turn speed is controlled according to the lift height, load weight, and turning radius, providing stable turning matched to the state of operation.

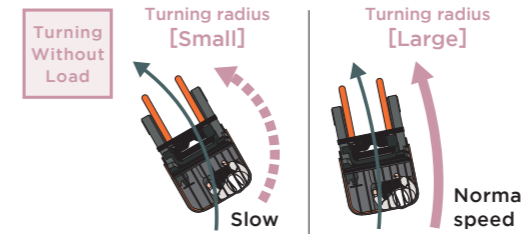

Vehicle speed adjusted according to turning radius

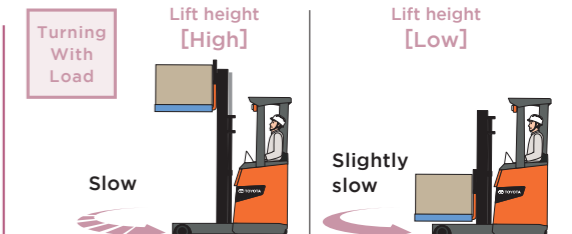

Vehicle speed adjusted according to turning radius, load weight and lift height.

### Suspension Control



### Supports Stable Turning and Load-handling Operations

This helps to prevent front and rear wheels floating by locking the suspension as required, contributing to provide stability during traveling and load-handling operations, and boost productivity.

### Suspension Control

#### During Turns

Swing of the suspension during turns is locked as necessary, contributing to prevent front wheel from floating.

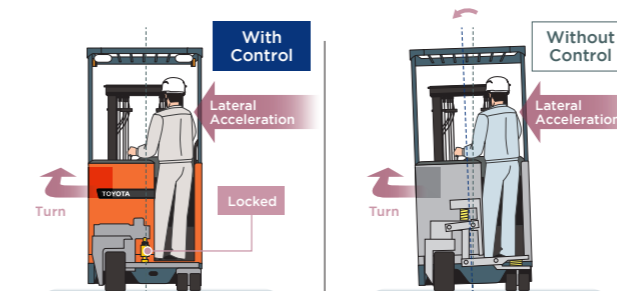

Ensured stability during load handling



Swing lock indicator

#### During Load Handling at High Lift Height

At lift height over 3 meters, this locks the suspension, achieving outstanding longitudinal and lateral stability. Even at low lift height, this locks the suspension during reach-out.

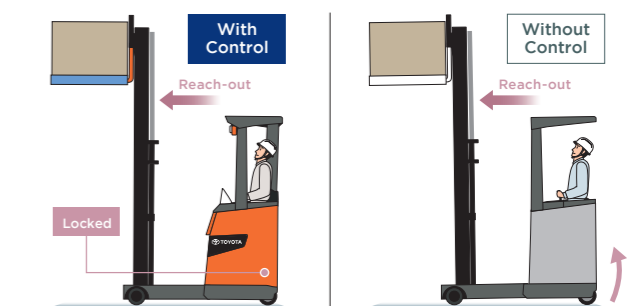

No capacity reduction at lift height of 4m

# Smooth Start-off, Travel, and Braking, Stress Free Operation in Your Hand.

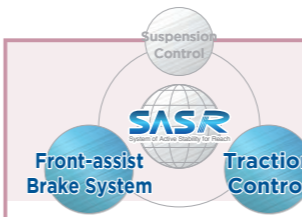

## Stable Brake, Start-off and Switchback

SAS-R makes stable and short distance braking possible. It contributes smooth switchback operation which operated frequently on reach trucks. What's more, it suppresses tire wearing and tire mark on the floor.

### Front-assist Brake System

The truck is equipped with front-wheel brakes, which enable stable braking even when the drive wheels lock up.

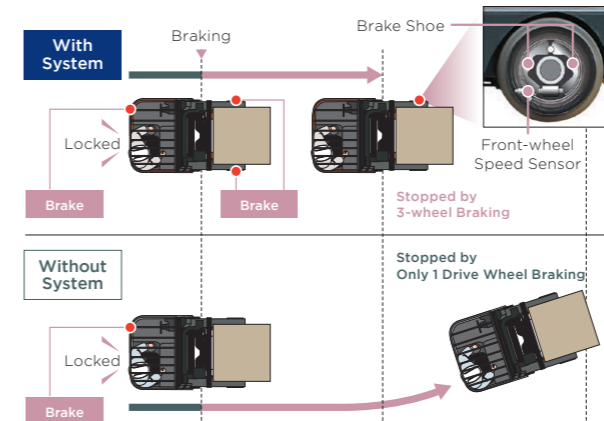
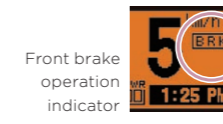

Stable Braking by the Front and Rear Wheels

### Traction Control

This detects spinning of the rear wheel and controls drive force accordingly. This eliminates the need for fine adjustment of steering and acceleration on slippery surfaces.

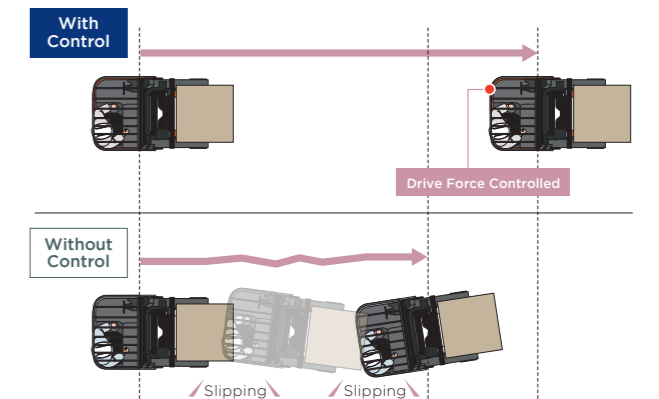

Supporting Smooth Start-off by Preventing Spinning of the Drive Wheel

### Common Reach Trucks

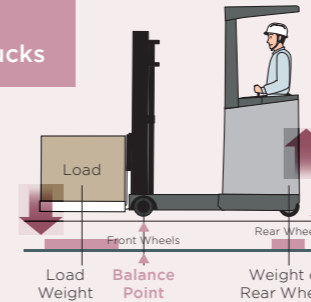

Reach trucks balance the vehicle body with the load, taking the front wheels as the balance point. Therefore when a reach truck travels while carrying a load with reach-out, the pressure against the ground on the rear wheel - the drive tire - is reduced, and spinning of the wheels becomes more likely to occur. It also makes steering and braking less effective.

Low Rear Wheel Pressure Against the Ground → Tire Spinning and Difficulty in Turning and Stopping

### LED Blue Light

NEW Option

A blue spot light appears on the ground to inform pedestrians of the forklift's presence, and helps prevent accidents.

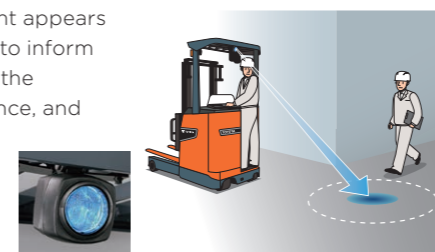

### Anti-rollback

When the acceleration lever is released on a grade, the forklift stops for a while and then descends at a constant speed. This helps to ensure smooth operation on slopes.



### Operator Presence Sensing System (OPS)

OPS

If the operator is not in the normal operating position, travel power is interrupted and load-handling operations are stopped.

Note: OPS does not operate the brakes. Always set the parking brake before leaving the forklift.



OPS Activated

OPS Indicator

# Comfortable Design and Operator-friendly Features for Day-to-day Operations.

250

Floor height  
 1 ton series **250 mm**  
 2 ton series **315 mm**



Floor height (1 ton series): 250mm

## Easy Operation

### Operator's Compartment



Two assist grips, pencil & cup holders and flat top panel support comfortable operation. The rounded configuration helps keep the body inside.



- 1 Back support with integrated assist grip **NEW**
- 2 Assist grip
- 3 Pencil holder **NEW**
- 4 Cup holder **NEW**
- 5 Spacious flat top panel
- 6 Small-diameter steering wheel
- 7 Hand protector

### Panoramic Mirror **NEW** Option

The curved-surface mirror provides broad view of operator's back side.



### Laser Marker Option

The bright laser marks the height of the forks. It supports smooth pallet handling in the warehouse.

Note: This is an image photo. The actual appearance of the laser beam is different.



### Fork Leveling Indicator Lamp **NEW** Option

The lamp installed on the mast lights up when the forks are at level position. This helps to confirm the forks are level, even when the front view is blocked.

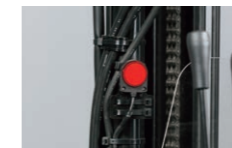

### Fork View Camera **NEW** Option

The fork tips are displayed on a monitor for easy fork insertion even at high lift height. Horizontal line displayed on the monitor indicate the fork height.



### Angled Lower Stays for the Backrest

This provides outstanding fork tip visibility when fork lowering, and helps the operator maintain a strain-free operating posture during load handling.



### Height Selector II **NEW** Option

The forks automatically stop at preset positions. It makes operations simple and easy. The lift height can be set at 18 different positions matched to your worksite.

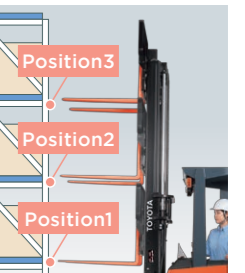

### Multifunction Lever Option

All reach truck operations can be controlled by this lever. The Multifunction Lever will surely support the productivity of all levels of operators.



\*Only for the vehicle with side shift fork.

# Easy Maintenance and Easy Management, Totaly Supports Your Worksite.

## Maintenance

### Battery Reach Out System

The battery can be reached out easily. It enables smooth battery maintenance, inspection, and replacement.



Reach Lever

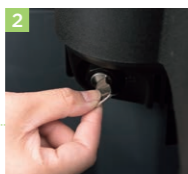

Key Switch

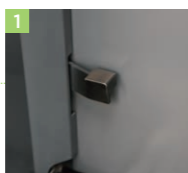

Release Pedal

To prevent unintentional operation, battery is reached out only when 1, 2, and 3 are operated simultaneously.

### Battery Connector Handle with Long Grip

\*Only for on-truck charger

The charger plug with long grip and the angled charging port support easy connection. The rubber plug is superior in durability.



### Charging Plug inside Operator's Compartment

The battery charging port for off-truck charger is located at the operator's compartment. This eliminates the need to disconnect the plug from battery, enhancing ease of operation.



### Detachable Front Cover

The front cover is easy to detach and reattach, facilitating inspection and maintenance.



## Management

### PIN\*-code Entry System

\*Personal Identification Number

A code must be entered to start the forklift, preventing use by unauthorized persons. The vehicle settings can be registered, allowing preferred settings for different operators. This also provides keyless operation.



### Deluxe Multifunction Display

Enables operators to access a wide range of information about the forklift, such as travel speed and battery capacity. It also provides setting functions.

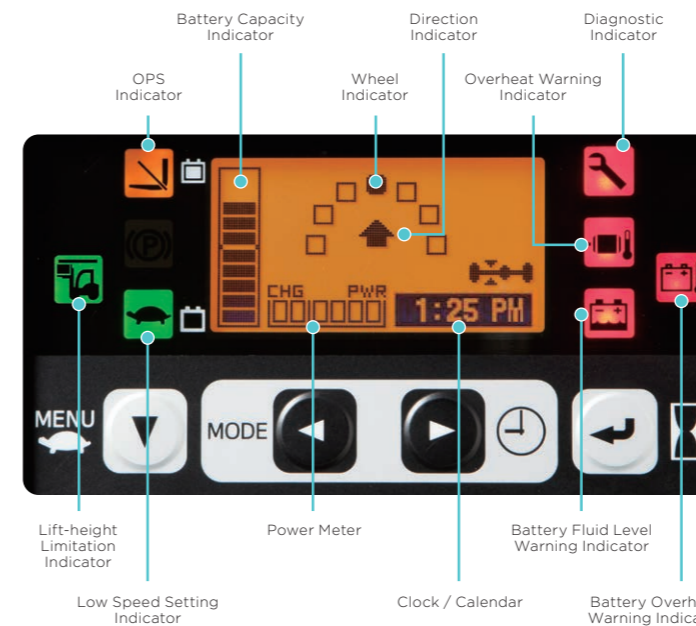

### Speedometer

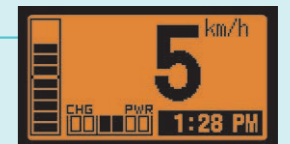

### Hour Meter

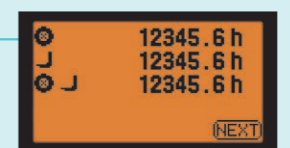

### Over-speed Alarm



### Maximum Speed Limit



### Scheduled-maintenance Hour Indicator



### Battery Data Logging

\*Only with Battery Protecting Function and optional battery

This provides the useful data such as battery charge status for improving battery maintenance and charging operations. Data can be output via QR code.



The following data are recorded by month, up to one year.

Number of Days in Operation

Key-on Hours

Fluid-level Warning Time

Charge Status

### Telematics LSite

The state of trucks operation, battery status, trucks collision information, and other data can be viewed on a computer or tablet. This can be used for improvements of worksite such as safety management, enhancement of productivity, and cost reductions.



# OPTIONS

Specifications Optimized to the Usage Environment



## Operator Side Protector Option

The steel protector helps to guard the operator's shoulder and elbow from harm.



## Resin Roof Option

Easily detachable clear roof helps to provide protection from small falling objects. It is also effective against rain showers.



## LED Headlights Option

LEDs provide bright illumination with far less power consumption and offer considerably longer life.



## LED Yellow Beacon Option



## LED Search Light Option

The compact yet bright light provides good forward visibility by illuminating the fork tips and other areas.



## Cold-storage Model Option

Cold-storage Model is designed for the operation in cold-storage warehouse. Cold-resistant hydraulic hoses, and special rust-proof coating and paints are used to withstand the extremely low temperatures. The charging port placed inside the operator's compartment makes charging easier.



Note: Continuous inside operation time is up to 30 minutes. After inside operations, it is necessary to keep the truck outside for an equivalent length of time.

## A4-size Binder with Clear Cover Option

The clear cover protects documents from water droplets. It is also useful when checking documents inside cold-storage.

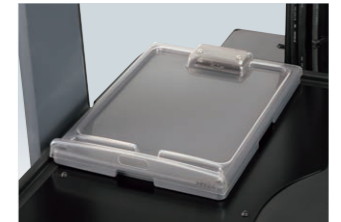

## Rear Bumper (Rubber) Option

In the rare event of an accident, the D-shaped rubber bumper helps reduce damage.

Note: The turning radius is increased by 120 mm compared with the base vehicle.

## Main Equipment ○ Standard ● Optional

Equipment	Availability
<b>Safety &amp; Stability</b>	
SAS-R	○
Automatic Turn-speed Control	○
Rear-positioned Headguard Pillar	○
OPS	○
Hand Protector	○
Shockless Landing	○ *1
Turn Signal Lights	○
Headlights	○
LED Headlights	●
LED Rear Working Light	●
LED Search Light	●
LED Blue Light (Selective Lighting Condition)	●
LED Yellow Beacon	●
Rear-view Mirror Oval Type	●
Panoramic Mirror	●
Back-up Light	●
Forward & Back-up Chime	●
Back-up Chime	●
Forward Chime	●
Rear Bumper (Rubber)	● *2
Instrument Panel Guard (w/ Reinforced Left Hand Body)	● *2
Reinforced Left Hand Body	● *2
Operator Side Protector	●
Clamp Interlock	●
<b>Battery</b>	
Battery (Wet Cell)	●
Smart Charging System [Battery Charger (On-Truck Type)]	●
Battery Charger (Off-truck Type)	●
Single Overall Electrolyte Filler Ports	●
Charger Plug Inside Operator Compartment	●
Battery Protecting Function	●
Battery Carrier	● *2
Battery Carrier w/ Height-adjust System	●
Battery Hanger	●
Handle For Side Pull-out Battery	●
Side Pull-out Battery	●

Equipment	Availability
<b>Operability &amp; Comfort</b>	
Back Support with Integrated Assist Grip	○
Multifunction Lever	● *2
Rear Pillar Pad	●
Overhead Guard Sheet	●
Resin Roof	●
Reading Lamp	●
Document Box w/ Magnet	●
Storage Box w/ Cup Holder	●
A4-size Binder w/ Magnet	●
A4-size Binder w/ Clear Cover	●
<b>Service &amp; Management</b>	
Deluxe Multifunction Display	○
Keyless Key Switch	●
PIN Code Entry System	●
Telematics	●
<b>Load handling</b>	
Height Selector II	● *3
Fork Leveling Indicator Lamp	● *4
Laser Marker	● *4
Fork View Camera	● *4
Wide Visible Mast (V)	○ *5
Wide Visible Mast (SV)	● *6
Full-free Lift 3-stage Mast (FSV)	● *3
Full-free Lift 2-stage Mast (FV)	●
Fully Oil Charged Lift Cylinder	●
High Load Backrest (Flat Steel Type)	●
Reinforced High Load Backrest (Angle Shape Type)	● *2
Long Backrest (Flat Steel Type)	● *2
Reinforced Long Backrest (Angle Shape Type)	● *2
Sleeved Forks	●
<b>Special Edition</b>	
Cold Area Package	●
Cold-storage Model (Type 45S)	●
Rust-proof Model	●
Mast Rust-proof Painting	●
Backrest Rust-proof Painting	●
Bumper Type Sub-weight	●

\*1 Only for V, SV and FSV mast \*2 Only for 8FBR10-18 \*3 Except 8FBR20,25  
\*4 Except 8FBR30 \*5 Option for 8FBR20,25 \*6 Standard for 8FBR20,25